

**SONY**

3-752-483-21 (1)

# ***Compact Disc Player***

---

Operating Instructions



**CDP-X555ES**

## Warning

**To prevent fire or shock hazard, do not expose the unit to rain or moisture.**

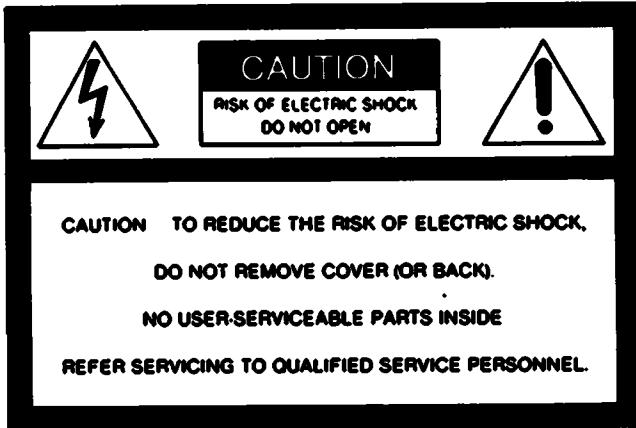

This symbol is intended to alert the user to the presence of uninsulated "dangerous voltage" within the product's enclosure that may be of sufficient magnitude to constitute a risk of electric shock to persons.



This symbol is intended to alert the user to the presence of important operating and maintenance (servicing) instructions in the literature accompanying the appliance.

## Information

This equipment generates and uses radio frequency energy and if not installed and used properly, that is, in strict accordance with the manufacturer's instructions, may cause interference to radio and television reception. It has been type tested and found to comply with the limits for a Class B computing device in accordance with the specifications in Subpart J or Part 15 of FCC Rules, which are designed to provide reasonable protection against such interference in a residential installation. However, there is no guarantee that interference will not occur in a particular installation. If this equipment does cause interference to radio or television reception, which can be determined by turning the equipment off and on, the user is encouraged to try to correct the interference by one or more of the following measures:

- Reorient the receiving antenna
- Relocate the equipment with respect to the receiver
- Move the equipment away from the receiver
- Plug the equipment into a different outlet so that equipment and receiver are on different branch circuits.

If necessary, the user should consult the dealer or an experienced radio/television technician for additional suggestions. The user may find the following booklet prepared by the Federal Communications Commission helpful: "How to Identify and Resolve Radio-TV Interference Problems". This booklet is available from the U.S. Government Printing Office, Washington, DC 20402, Stock No. 004-000-00345-4.

## For the customers in Australia

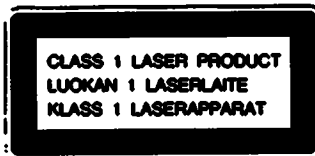

This Compact Disc player is classified as a CLASS 1 LASER product. The CLASS 1 LASER PRODUCT label is located on the rear exterior.

## Owner's Record

The model and serial numbers are located at the rear. Record these numbers in the spaces provided below. Refer to these numbers whenever you call upon your Sony dealer regarding this product.

Model No. CDP-X555ES Serial No. \_\_\_\_\_

# Table of Contents

Introduction .....	3
Safety precautions .....	4
Installation .....	4
Connections .....	5
Location of controls .....	6
Front panel .....	6
Remote commander .....	7
Installing batteries in the remote commander .....	7
<b>Playing a disc — Continuous play</b> .....	8
Information display .....	9
Locating a particular selection .....	10
Locating a particular point in a selection .....	10
Locating an index .....	11
To play a selection immediately from the beginning	
— Auto cue .....	11
Fading in/Fading out .....	11
<b>Playing in a random order — Shuffle play</b> .....	12
<b>Playing only the desired selections — Delete play</b> .....	13
To delete the undesired selection before playing .....	13
To delete a selection during play .....	13
<b>Playing the beginning of each selection — Music scan</b> .....	14
Music scan .....	14
Music scan delete play .....	14
<b>Playing repeatedly — Repeat play</b> .....	15
Repeating selections .....	15
Repeating a particular portion — A ~ B repeat .....	15
<b>Playing in a desired order — Program play</b> .....	16
Designating the playing time — Program edit .....	16
<b>Designating the playing order of up to 6 discs</b>	
— Multi-disc program .....	18
<b>Designating the total playing time</b>	
— Time edit/Just edit .....	20
<b>Tips on editing tapes</b> .....	22
Fading out at the desired time — Time fade .....	22
Inserting a blank space between selections	
— Auto space .....	22
Locating the loudest portion of the disc	
— Peak search .....	22
<b>On custom files</b> .....	23
Five custom files you can store in memory .....	23
<b>Keeping the program in memory — Program bank</b> .....	24
Memorizing program .....	24
Playing the disc using the program bank .....	24
Clearing the program bank .....	24
<b>Keeping your desired selections in memory</b>	
— Delete bank .....	25
Memorizing desired selection .....	25
Playing the disc using the delete bank .....	25
Clearing the delete bank .....	25
<b>Assigning names to a disc — Disc memo</b> .....	26
Clearing the disc memo .....	27
<b>Giving a disc indexes as you want — Custom index</b> .....	28
Playing from the desired custom index .....	28
Clearing custom indexes .....	28
<b>Storing an optimum playback level for each disc</b>	
— Level file .....	29
Clearing the level file .....	29
<b>Timer activated playing</b> .....	30
<b>Maintenance</b> .....	31
Cleaning your unit .....	31
Cleaning discs .....	31
<b>Specifications</b> .....	31
<b>Troubleshooting guide</b> .....	back cover

# Introduction

## Enjoy listening in various playing modes

You can select the playing modes among the following:

- Continuous play (page 8) — The entire disc is played once.
- Shuffle play (page 12) — Selections are played in a random order.
- Delete play (page 13) — Selections of your choice are played in the order you desire.
- Repeat play (page 15) — Selections or portions are played repeatedly.
- Program play (page 16) — Selections are played in your desired order.

## Editing your own tapes

- You can fade in or out the play when making your own tape recording. — Fade in/Fade out (page 11)
- CUSTOM EDIT function
  - You can designate the playing order of up to 6 discs. — Multi-disc program (page 18)
  - You can confirm the total playing time while choosing the selections to be programmed. — Program edit (page 16)
  - The player can program selections automatically to fit in a desired duration. — Time edit/Just edit (page 20)
  - You can stop the play, fading out at the time desired. — Time fade (page 22)
  - The loudest portion of the disc will be determined and played repeatedly. — Peak search (page 22)

## You can play a beginning of each selection

You can check the selections by scanning the beginning of each selection in the disc. — Music scan (page 14)

## Making your disc custom-made — CUSTOM FILE function

- You can store the programmed playing order for a disc. — Program bank (page 24)
- You can keep your desired selections in memory — Delete bank (page 25)
- You can assign a name to a disc, such as the title of the disc or the date of purchase. — Disc memo (page 26)
- You can assign your own index point to any desired position on a disc. — Custom index (page 28)
- You can store the optimum playback level of each disc in the unit's memory. — Level file (page 29)

## You can make 3-second blanks between selections

The blank space enables you to locate selections when using a tape deck with the automatic selection search function.

## Easy-to-see display

The selection number, the playing time, the remaining time are displayed by pressing the TIME/MEMO button.

In addition, you can change the desired display information by selecting three patterns. Adjusting the brightness of the display by selecting three patterns.



This indicates a function operated only from the remote commander.



This indicates a function operated only on the main unit.

## Safety Precautions

- Check the unit's operating voltage before operation. It must be identical with that of your local power supply. The operating voltage is indicated on the nameplate at the rear of the unit.
- Stop operation immediately if any liquid or solid object should fall into the cabinet. Unplug the unit and have it checked by qualified personnel.
- Unplug the unit from the wall outlet if you will not use it for a long time. Disconnect the cord by grasping the plug. Never pull the cord itself. The unit is not disconnected from the mains as long as it is plugged into the wall outlet, even if the unit itself has been turned off.
- Do not disassemble the cabinet. The laser beam used in this unit is harmful to the eyes when uncovered. Refer servicing to qualified personnel only.

For detailed safety precautions, see the leaflet "IMPORTANT SAFEGUARDS".

If you have any questions or problems concerning your unit, please contact your nearest Sony dealer.

## Installation

### Placing Your Unit

- Place the unit in a location with adequate air circulation to prevent internal heat build up in the unit.
- Do not place the unit on a soft surface, such as a rug that would block the ventilation holes on the bottom.
- Do not install the unit:
  - near heat sources such as radiators or air ducts.
  - in a place subject to direct sunlight, excessive dust, mechanical vibration or shock.

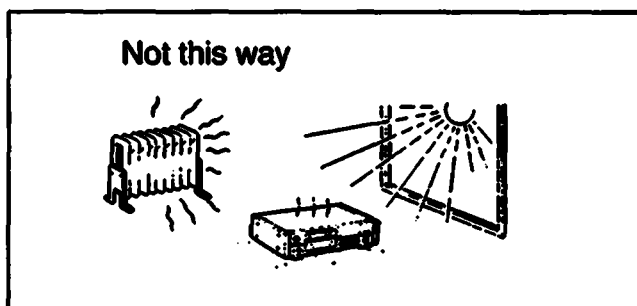

### On moisture condensation

If the player is brought directly from a cold to a warm location, or is placed in a very damp room, moisture may condense on the lens inside the unit. Should this occur, the player will not operate. In this case, remove the disc and leave the player turned on for about an hour until the moisture evaporates.

### Detaching the Side Panels

After removing the screws, secure the cabinet with the supplied lock screws. Do not use the longer screws. For safety, before doing this, be sure to disconnect the AC power card from the AC outlet.

### Note on Packing Material

Before playing this unit for the first time, be sure to remove the packing material from the disc compartment.

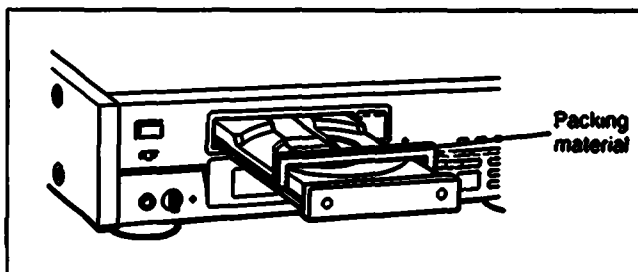

# Connections

You can connect the unit with analog or digital signal depending on your amplifier or D/A converter.

## For Correct Connections

- Turn off the power of each unit before making connections.
- Connect the AC power cord last.
- Be sure to insert the plugs firmly into the jacks. Loose connection may cause hum and noise.
- Leave a little slack in the connecting cord to allow for inadvertent shock or vibration.
- Cord plugs and jacks are color coded: Red plugs and jacks are for the right channel (R) and white ones for the left channel (L).

## To Connect to an Amplifier

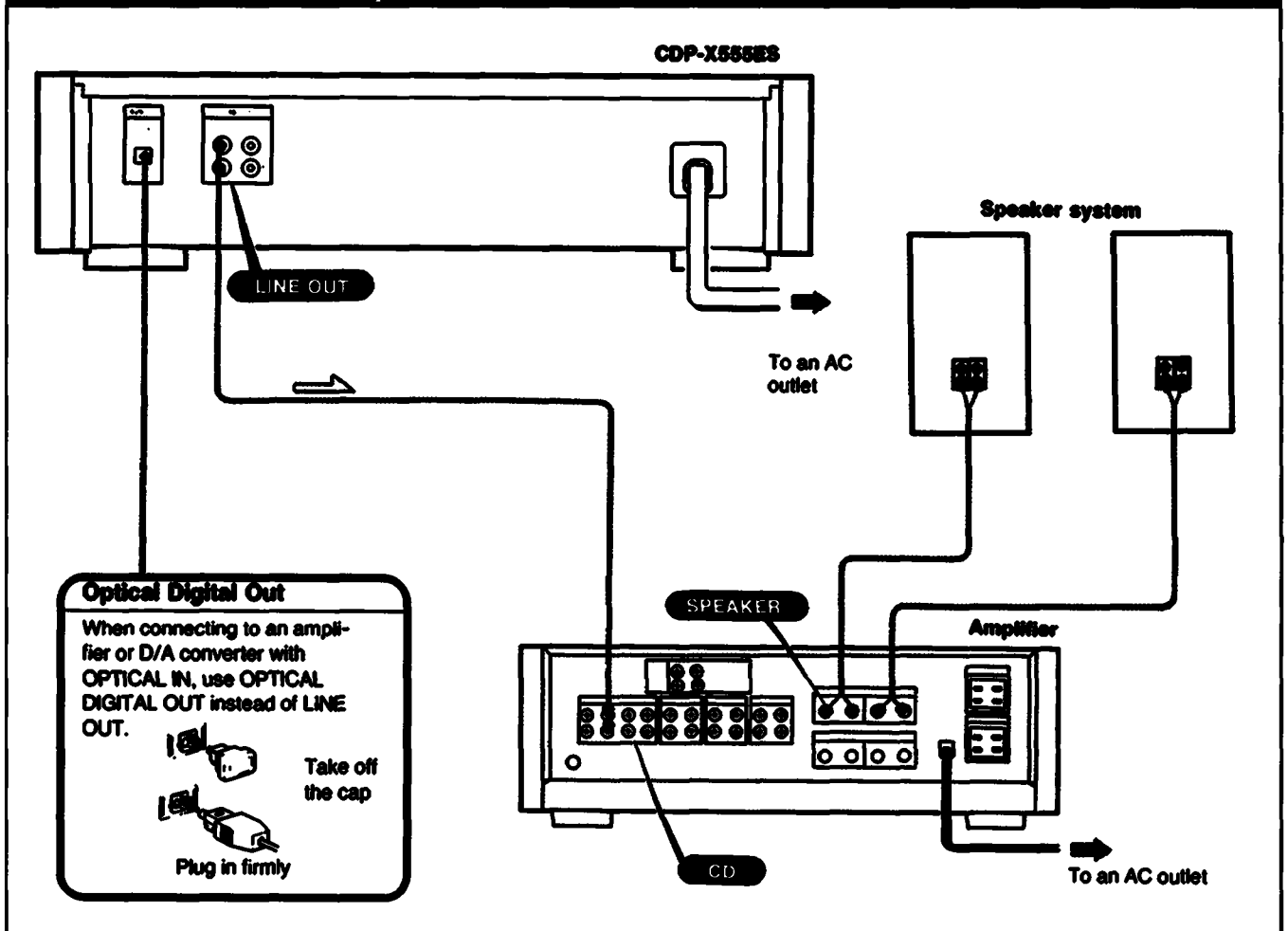

### Note on DIGITAL OUT

When connecting with DIGITAL OUT (OPTICAL), use the POC-15 audio optical connecting cord (optional). Please note that when the digital out is connected, fade out, fade in, time fade and level file functions cannot be used.

### Notes on LINE OUT\*

**FIXED:** The output level is fixed.  
**VARIABLE:** The output level can be adjusted with the LINE OUT/PHONE LEVEL control or LINE OUT LEVEL on the remote commander.

- Connect your system to the VARIABLE output when using level file.

Note, if the LINE OUT/PHONE LEVEL control is turned while recording, the recording level will change even when it is preset on the tape deck.

# Location of Controls

## Front Panel

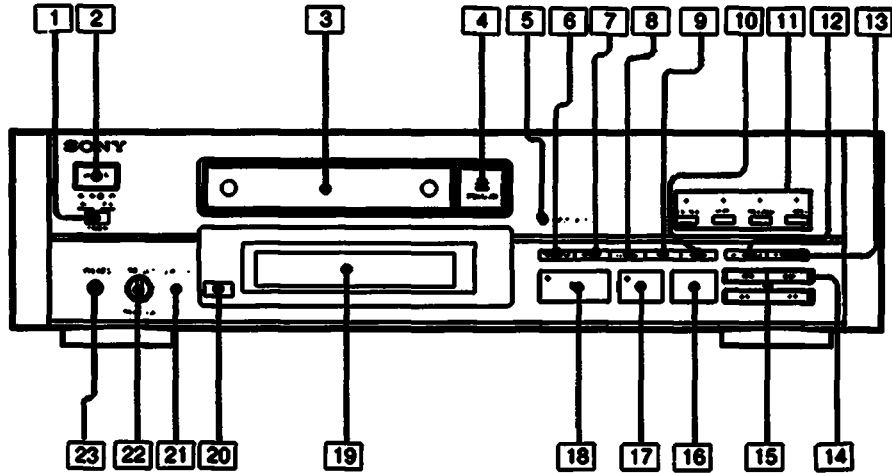

Refer to the pages indicated in ● for details.

- 1 TIMER switch ●
- 2 POWER switch ●
- 3 Disc tray ●
- 4 ▲ OPEN/CLOSE button ●
- 5 DISPLAY MODE button ●
- 6 TIME/MEMO button ●
- 7 REPEAT button ●
- 8 FILE RECALL button ●
- 9 FILE (custom file) button ●
- 10 ERASE (memory erase) button ●
- 11 PLAY MODE buttons  
CONTINUE button and lamp ●  
SHUFFLE button and lamp ●  
PROGRAM button and lamp ●  
C. (custom) INDEX button and lamp ●

- 12 EDIT/TIME FADE button ●
- 13 P. (peak) SEARCH button ●
- 14 ◀▶ (manual search) buttons ●
- 15 ◀▶▶ AMS\* buttons ●
- 16 ■ (stop) button ●
- 17 || (pause) button ●
- 18 ▶ (play) button ●
- 19 Display window ●
- 20 Remote sensor
- 21 LEVEL FILE button ●
- 22 LINE OUT/PHONE LEVEL control ●
- 23 PHONES jack ●

\* AMS is the abbreviation of Automatic Music Sensor.

## Remote Commander

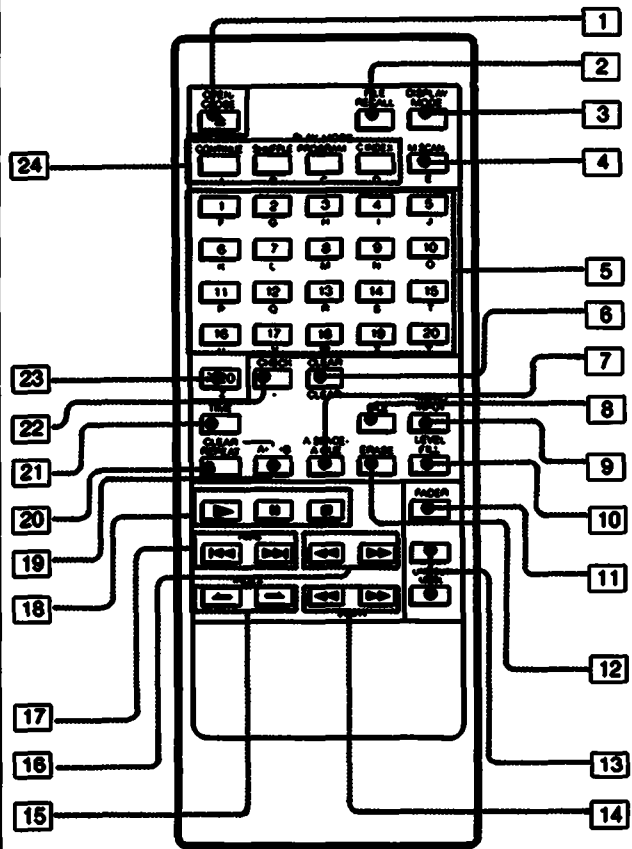

Refer to the pages indicated in ● for details.

- 1 ▲ OPEN/CLOSE button ●
- 2 FILE RECALL button ●
- 3 DISPLAY MODE button ●
- 4 M. (music) SCAN button ●
- 5 Numeric buttons ●
- 6 CLEAR button ●, ●
- 7 A. SPACE (auto space)/A. CUE (auto cue) button ●, ●
- 8 FILE (custom file) button ●
- 9 MEMO INPUT button ●
- 10 LEVEL FILE button ●
- 11 FADER (fade in/fade out) button ●
- 12 ERASE button ●
- 13 LINE OUT LEVEL (line out/headphone level) buttons ●, ●
- 14 ◀▶▶ SLOW (low speed manual search) buttons ●
- 15 ◀ ▶ INDEX buttons ●, ●
- 16 ◀▶▶ (manual search) buttons ●
- 17 ◀▶▶▶ AMS buttons ●
- 18 ■ (stop) button ●
- 19 || (pause) button ●
- ▶ (play) button ●
- 19 A ~ B repeat button ●
- 20 CLEAR REPEAT button (A ~ B repeat clear/repeat) button ●
- 21 TIME button ●
- 22 CHECK button ●
- 23 > 20 (over 20) button ●
- 24 PLAY MODE buttons  
CONTINUE button ●  
SHUFFLE button ●  
PROGRAM button ●  
C. (custom) INDEX button ●

Buttons with yellow letters (A, B, C, ..... ) are for writing a disc memo (page 26).

## Installing Batteries in the Remote Commander

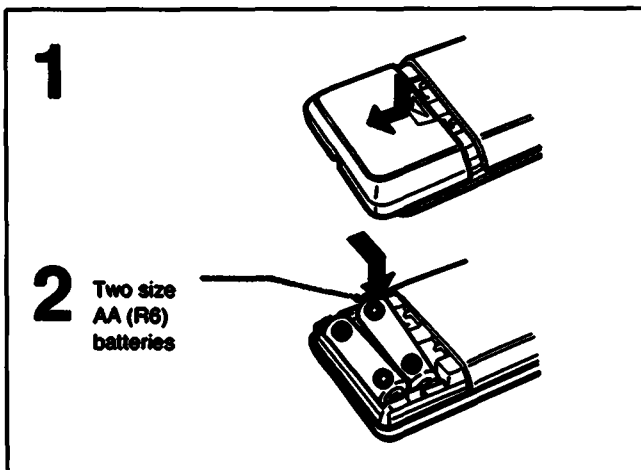

### On battery life

- About half a year of normal operation can be expected when using the Sony SUM-3(NS) batteries.
- When the batteries are run down, the remote commander will not operate the unit. In this case, replace both batteries with new ones.

### Notes on the remote commander and remote control operation

- Keep the commander away from extremely hot or humid places.
- Avoid dropping any foreign objects into the commander casing, particularly when replacing the batteries.
- Avoid exposing the remote sensor to direct sunlight or lighting apparatus. Such exposure can cause a malfunction.
- To avoid damage caused by battery leakage and corrosion, remove the batteries when the commander will not be used for a long time.

# Playing a Disc

## — Continuous Play

Before playing a disc, turn on the amplifier and set the input selector to the CD player position.

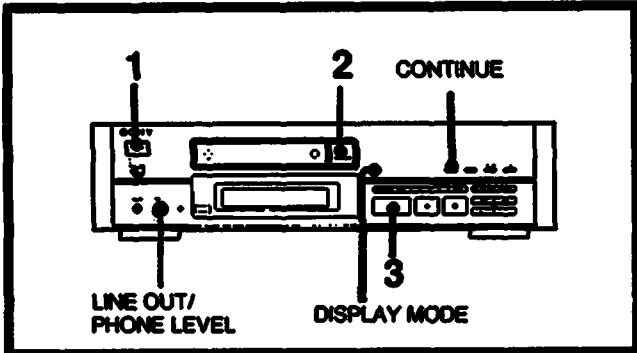

### To stop play

To stop for a moment during play, press II.

Press II or ► to resume play.

To stop play, press III.

To stop play and open the tray, press ▲.

### To control the volume

When you use VARIABLE, adjust the volume with LINE OUT/PHONE LEVEL control of the player or LINE OUT LEVEL of the remote commander. Press + of the remote commander to turn up the volume and press - to turn down the volume. When you press + or -, the LINE OUT/PHONE LEVEL control of the player rotates automatically.

### Caution on adjusting volume

Do not turn up the volume while listening to a portion with very low level inputs or no audio signals. If you do, the speakers may be damaged when a peak level portion is played.

1

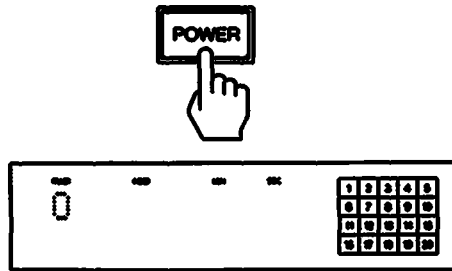

If the indicator above the CONTINUE button does not light up, press the CONTINUE button.

2

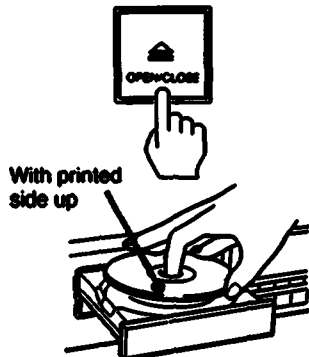

### When listening with headphones

Connect the headphones and adjust the volume with the LINE OUT/PHONE LEVEL control or LINE OUT LEVEL of the remote commander.

### Note on the TIMER switch

Leave the TIMER switch off when you are not using timer activated play. (For further details, refer to page 30).

### If disc contains more than 20 selections

► appears in the display window behind 20 on the music calendar.

### What is this indication?

-NO DISC-

This indication appears when the disc compartment is empty. The indication can be changed to a customized indication (page 26).

### To play a 8 cm (3-inch) CD

Place it on the inner circle of the tray. If the disc is provided with an adaptor, first remove it. Do not put a normal CD (12 cm/5-inch) on top of a 8 cm CD.

### Notes on handling discs

- To keep the disc clean, handle the disc by its edge. Do not touch the surface.
- Do not stick paper or tape on the disc.



- Do not expose the disc to direct sunlight or heat sources such as hot air ducts, or leave it in a car parked in direct sunlight as there can be a considerable rise in the temperature.
- After playing, store the disc in its case.

3

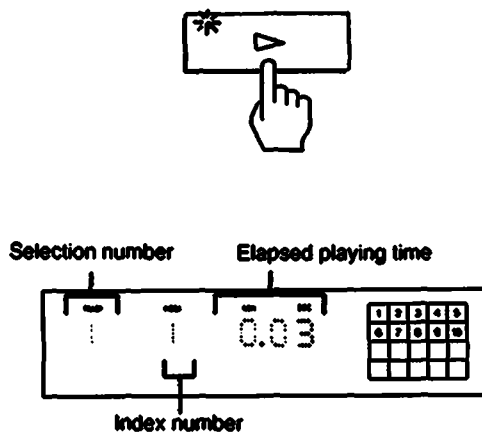



## Information Display

Each time you press TIME/MEMO (or TIME on the remote commander) during play, the display changes to give you the following information.

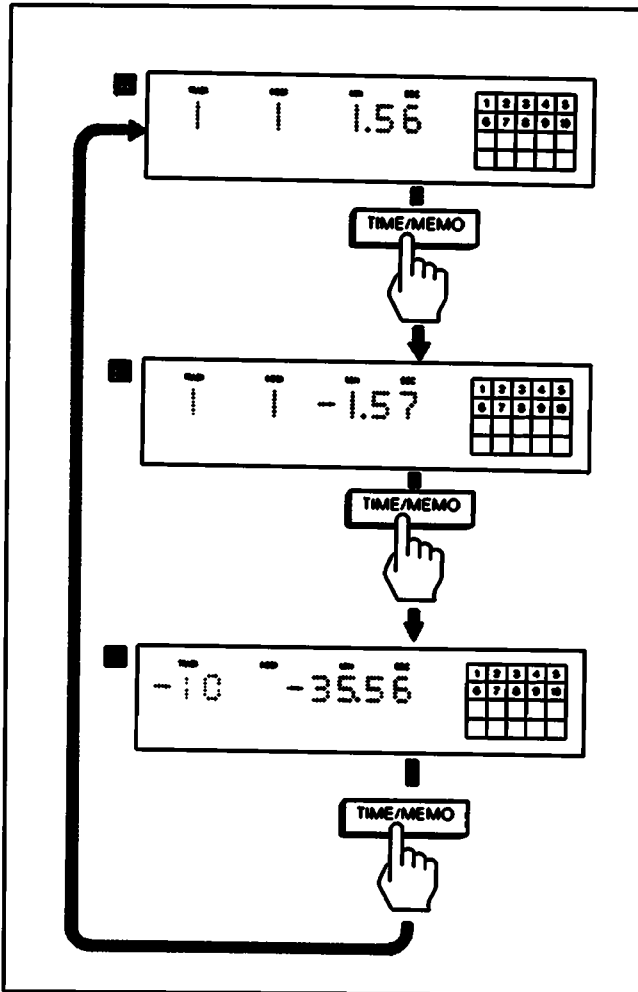

- Elapsed playing time
- Remaining time in a selection  
If the current selection number is over 24, "-----" is displayed.
- Remaining number of selections and total remaining time.

### *If you have stored a disc memo*

The stored disc memo will be displayed, following the display of the remaining time of the disc.

*If you press TIME/MEMO (or TIME on the remote commander) during stop*

The total playing time and total number of selections will be displayed.

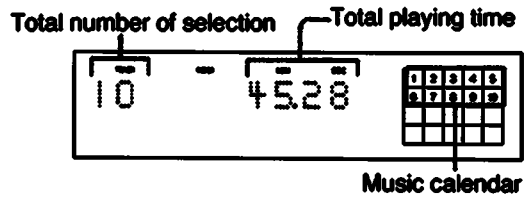

### To change the parts of information display

Each time you press the DISPLAY MODE on the remote commander during play, the display changes to give you the following information.

→ Entire display On → Track number, index number and playing time On → Entire display Off ←

### To adjust the brightness of the display — DIMMER function

Press the REPEAT while holding down on the TIME/MEMO. The brightness adjustment has three tones. The tone you select will be stored in memory so that you do not have to adjust it again after turning the power off.

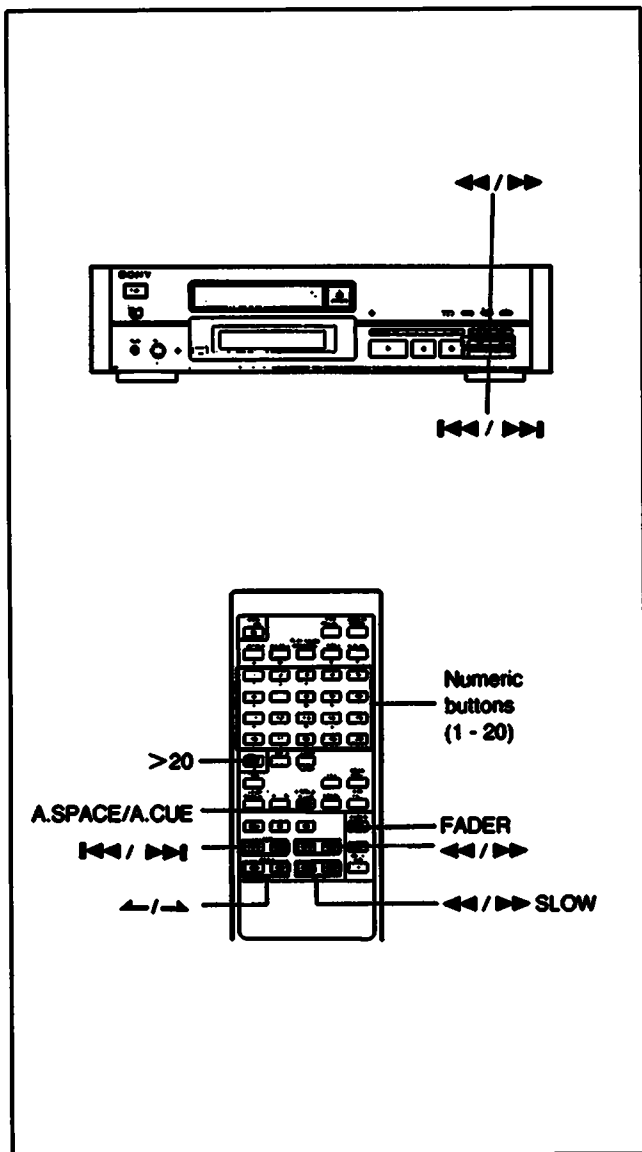

## Locating a Particular Selection

You can locate the beginning of a desired selection during play or pause.

### To locate sequentially

To locate the beginning of the current or preceding selection

- Press **⏮** as many times as required.
- Keep **⏮** pressed to skip selections.

To locate the beginning of the succeeding selection

- Press **⏭** as many times as required.
- Keep **⏭** pressed to skip selections.

When you press **⏮** during play

The player locates the beginning of the selection.



### To locate directly

Press one of the numeric buttons ( **1** to **20** ) to enter the desired selection number.

If a selection number is greater than 20, use the **>20** and **1** to **10** buttons. **10** functions as the figure 0.

e.g. To play from selection No.22 Press **>20** **2** **2**  
 To play from selection No.30 Press **>20** **3** **10**

## Locating a Particular Point in a Selection

You can locate a particular point in the disc during play.

### To search quickly while monitoring the sound

#### To go ahead at high speed

Keep **⏭** pressed during play and release at the desired point.

#### To go back at high speed

Keep **⏮** pressed during play and release at the desired point.

### To search quickly by observing the display

Press **⏏**, then keep **⏮** or **⏭** pressed. The search speed will increase, but there will be no sound. Find the desired point by observing the display. Press **⏏** or **⏭** again at the desired point.



### To search slowly while monitoring the sound

Press **⏮/⏭ SLOW** during play and release at the desired point.

### "-OVER-" is displayed

If you continuously press **⏭** at the end of the disc, "-OVER-" appears in the window. Press **⏮** or **⏮** to turn the normal indication.

If you continuously press **⏮** at the beginning of the disc, play begins automatically from the first selection.

## Locating an Index



This function is only possible with a disc on which index numbers are recorded.

Press ← or → to locate the desired index number. The selected index number appears in the display window.

### What is an index?

This is a number assigned to a section of a selection (for example, to a movement in a symphony) to allow that section to be located easily.

## To Play a Selection Immediately From the Beginning — Auto Cue



Auto cue lets you play right from the beginning of a given selection without having to listen to the blank lead-in.

### To use auto cue

1. Press the A.SPACE/A.CUE twice. "A.CUE" will appear in the window.
2. Press III and then make your selection by pressing the numeric button.

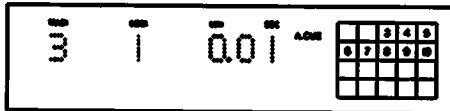

The time display will go out while the player is searching for the beginning of your selection. When the selection has been cued, the time display will come back on. (Some selections make take longer to find.)

3. Press ► or III. The selection will start immediately.

### To cancel auto cue

Press the A. SPACE/A. CUE again. "A.CUE" will disappear in the window.

### Note on auto cue

Selections that fade in slowly or have noise in the lead-in may not be picked up successfully by the auto cue function.

## Fading in/Fading out



You can have the play fade in/ fade out between 2-10 seconds.

When no time is specified, the play will fade in and fade out for 5 seconds.

This function cannot be operated when the DIGITAL (optical) OUT is used for connections.

### To set the fade time

1. Press ■.
2. Press FADER.
3. Press ◀/▶ to select fade time between 2–10 seconds.

### To end the play fading out

Press FADER when you want to start fading out.

 flashes in the window, and play fades out and enters the pause mode.

### To restart the play fading in

Press FADER in the pause mode.

 flashes in the window, and play fades in.

# Playing in a Random Order

## — Shuffle Play

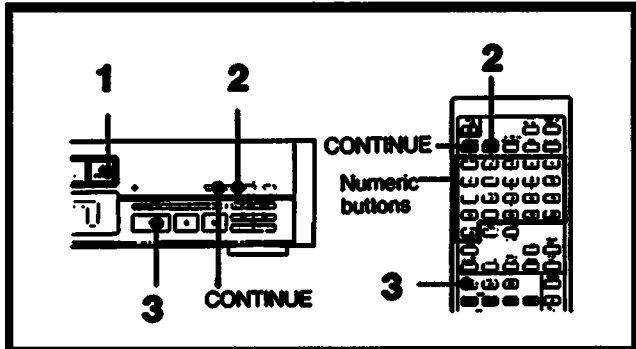

You can have the selections played in a random order. The unit will play all the selections, or just the selections you desire.

**To stop playing**  
Press ■.

**To cancel shuffle play**  
Press CONTINUE and return to the normal playing mode.

**To check the remaining time**  
Press TIME/MEMO (or TIME on the remote commander) once to see the remaining time of the selection being played; twice to see the total remaining time; once more to return to the initial display.

**If you press SHUFFLE during play**  
Shuffle play begins from the current selection.

 **What is this indication?**  
This indication appears while the player is "shuffling" the selections.

**To play only the desired selections in a random order — Delete Shuffle Play**

Delete the undesired selections before or during play.

**To delete a selection**, press the numeric button on the remote commander for that selection. "DELETE" will be displayed in the window. You cannot delete a selection which is being played.

To choose a selection number over 20, see page 10.

**To put back a selection which you have deleted**, press the numeric button on the remote commander for that selection. "SELECT" will be displayed in the window.

**To put back all selections which you have deleted**, press ■ during stop.

**If you press CONTINUE during delete shuffle play**  
Delete play begins from the current selection. (page 13)

# 1

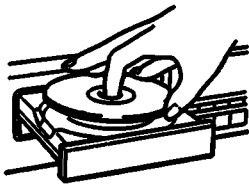

# 2



# 3



# Playing Only the Desired Selections

—Delete Play

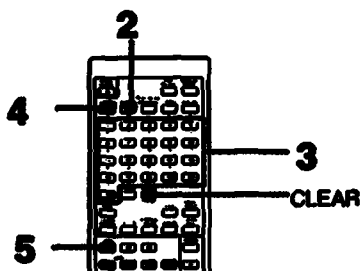

1

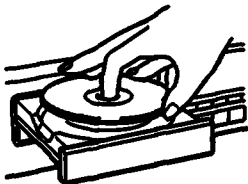

2



The indicator above the SHUFFLE button on the unit lights up.

3

Press the numeric button(s) of undesired selection number on the remote commander (to be deleted).\*



The number disappears.



\* To choose a selection number over 20, see page 10.

To put back a selection which you have deleted, press the numeric button on the remote commander for that selection. "SELECT" will be displayed in the window.

4



The indicator above the CONTINUE button on the unit lights up.

5



Your desired selections can be played continuously. You can set the mode before or during playing.

## To Delete the Undesired Selection Before Playing

**To stop playing**  
Press ■.

**When delete play ends**  
Selections except deleted ones will be restored.

**To put back all selections which you have deleted,** press ■ during stop.

*If you press SHUFFLE during delete play, your selections will be played in the Delete Shuffle play mode.*

*For a disc with selections over 24*  
The remaining time of the disc as a whole appears as "-----".

## To Delete a Selection During Play

This function can only be operated during continuous play or shuffle play.

**To delete a selection**  
Press CLEAR on the remote commander during a selection you do not desire to listen to. Next selection is played.

**When play ends**  
Selections except deleted ones will be restored.

**To play again**  
Press ►. Delete play starts.

**To put back a selection which you have deleted,** press the numeric button on the remote commander for that selection. "SELECT" will be displayed in the window.

**To put back all selections which you have deleted,** press ■ during stop.

**Note**  
You can keep the desired selections in memory for each disc by using the delete bank function. (Page 25).

# Playing the Beginning of Each Selection —Music Scan

You can check the selections by scanning the beginning of each selection in the disc.



## Music Scan

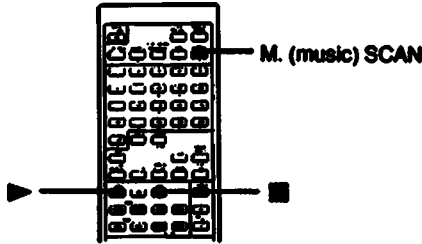

Press M.SCAN on the remote commander during stop.



**To change the playing time**  
Press M.(music) SCAN on the remote commander again. Each time you press M. SCAN on the remote commander, the display will be as follows:

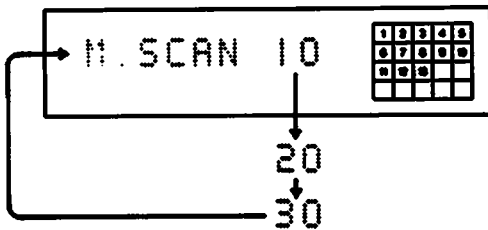

The indicator on the ► button blinks and beginning of each selection is played for 10, 20 or 30 seconds as designated and fades out.

You can use this function in any play mode.

**When scanning is finished,**  
the unit enters the stop mode.

**To start play immediately**  
Press ►. The indicator on the ► button lights up, normal playback will start from the selection being played.

**To stop music scan during scanning**  
Press ■.

### Notes

- When you press M. SCAN on the remote commander again, while playing the beginning of a selection, playing will be extended for 10, 20 or 30 seconds as designated.
- The scanning length for each selection will remain the same unless it is changed again.
- If you press ◀◀ / ▶▶, the music scan play will be canceled.

## Music Scan Delete Play

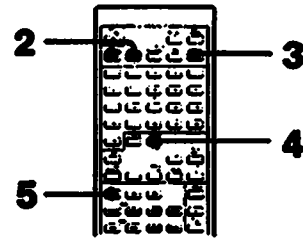

**1**

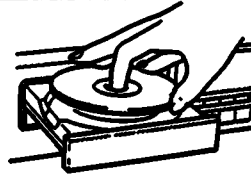

**2**

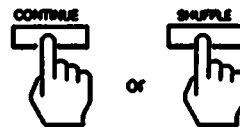

The indicator above the CONTINUE or the SHUFFLE button on the unit lights up

**3**



The indicator of the ► button on the unit blinks.

**4**

When playing the beginning of an undesired selection



The next selection will be played.

**5**

When the all selections have been played



This function can only be operated during continuous play or shuffle play.

**When music scan delete play ends**  
Selections except deleted ones will be restored.

**To put back a selection which you have deleted,**  
press the numeric button for that selection. "SELECT" will be displayed in the window.

**To put back all selections which you have deleted,**  
press ■ during stop.

# Playing Repeatedly

## —Repeat Play

You can choose between two different repeat play modes. One repeats selections in the current play mode, the other repeats any particular portion you like.

### Repeating Selections

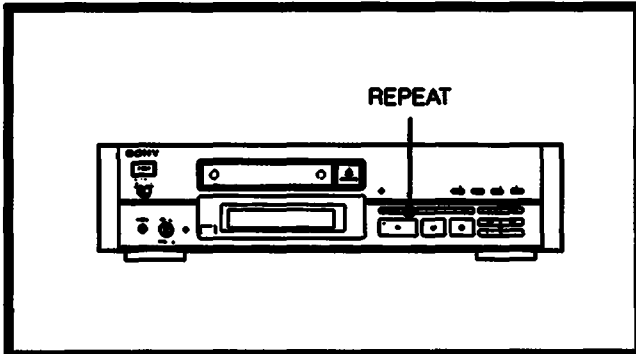

Press REPEAT (or CLEAR REPEAT on the remote commander) before or during play.



"REPEAT" appears in the window.

The unit repeats the current playing mode. To repeat a single selection, press REPEAT (or CLEAR REPEAT on the remote commander) again during repeat play of the continuous playing mode "REPEAT 1" appears.

Playing mode	Selections to be repeated
Continuous play	All the selections or a single selection
Delete play	Repeat playing selections except deleted ones
Shuffle play Delete shuffle play	Selections that the player reshuffles
Program play	All the selections programmed in the same order
Custom index play	Between the specific custom indexes

**Note**  
Repeat play cannot be conducted on multi-disc programs.

**To cancel repeat play**  
Press REPEAT (or CLEAR REPEAT on the remote commander) again. "REPEAT" disappears.  
To cancel repeat play of the continuous play, press "REPEAT" twice. "REPEAT" disappears.

### Repeating a Particular Portion —A ~ B Repeat

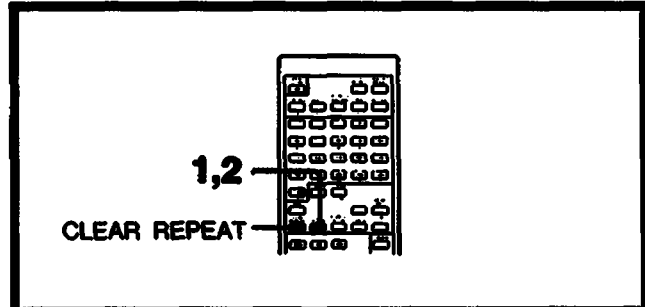

**1** Press at point A.



**2** Press at point B.

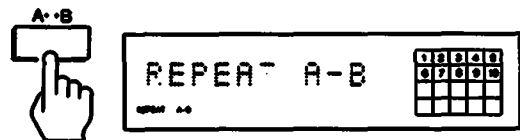

Play starts at point A.

You can repeat a portion on the disc by designating the starting point (A) and the ending point (B).

**To cancel A ~ B repeat**  
Press CLEAR REPEAT (or REPEAT on the unit).

**Going back to the same point (A) from any point on the disc**

Press A ~ B to designate the desired point (A). (Point B need not be designated.)

You can go back to point A from any point on the disc by simply pressing ►.

**Note**  
You cannot designate point A and B in two different selections.

# Playing in a Desired Order

## — Program Play

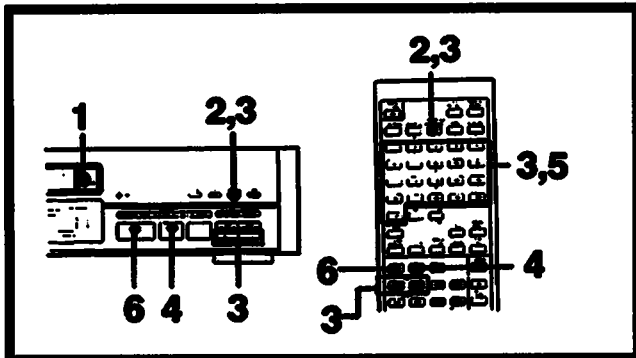

**1**

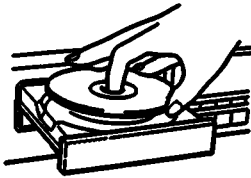

**2**



The indicator above the PROGRAM button on the unit lights up.

**3** This step can be operated only from the remote commander  
Press selection number in the desired order.\*

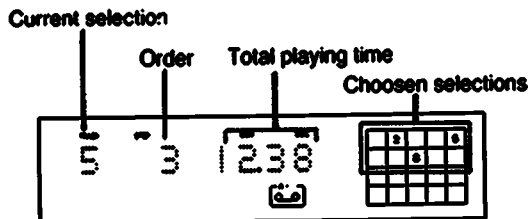

\* To choose a selection number over 20, see page 10.

## Designating the Playing Time

### — Program Edit

**A** Choose selection and check the time.

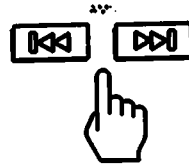

Current selection



Order Total time

Press ◀▶ repeatedly to choose an appropriate selection.

**B** A satisfactory selection has been chosen.



The selection is stored, and the flashing numbers in the window light up.

**4** If you program the selections for side B, insert a pause.

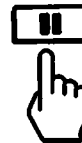

Order Total time will return to "0.00".

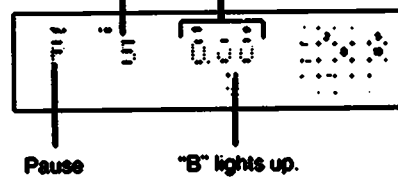

**5** Program the selections for side B.  
Repeat step 3.

**6**



The selections for side A will start playing.



You can make a program by designating up to 24 selections in the order you want them to be played. You can make a program for both sides (side A and side B) of the tape at one time. A pause is counted as one programming step. The unit will play the disc according to your program.

#### **To play the selections for side B**

When the selections for side A are played, the unit will pause. Set the tape to the beginning of side B ("B" lights up), then press ► or II.

The selections for side B will start playing.

#### **To stop playing**

Press ■.

You can play the same program repeatedly as long as you do not cancel program play or erase the program.

#### **To cancel program play**

Press CONTINUE and return to the continuous playing mode.

The program will be erased.

#### **To erase the entire program**

Press ■ once during stop; twice during play.

The program is also erased when you turn off the unit.

#### **When program play ends**

Each time a selection play ends, the corresponding selection number in the display window disappears. The program itself is not erased.

#### **To check your program**



Press CHECK the first selection in the program will be displayed.

Each time you press CHECK, the next selection in the program will be displayed. When CHECK is pressed after the last selection, "-END-" appears and then the display returns to the initial display.

#### **To change your program**



You can make the following changes before starting play.

#### **To erase the last selection, press CLEAR.**

Each time you press CLEAR, the last selection in the program will be erased.

**To add a selection to the end of the program, just press the numeric button for that selection. You can also add selections during play or pause.**

**To delete a selection, press CHECK repeatedly until the undesired selection is displayed. Then press CLEAR.**

**To change the order, press ■ during stop to erase the program. Then repeat the programming procedure from the beginning.**

#### **To adjust the blank spaces between selections**

In a program, if you do not change the order of selections, the spaces between those selections remain the same as on the disc. You can make all the blank spaces 3 seconds long. See page 22 for details.

Also, if the AUTO SPACE function is turned on, the playing time displayed for each selection will include an additional three seconds.

#### **When the power is turned off while playing a program selection**

The program is erased.

#### **When pressing PROGRAM during playing**

The current playing selection will be the first one. You can program while playing.

*If "-----" is displayed instead of the actual time*

- You have programmed a selection number over 24
- The total time is exceeded 100 minutes.

#### **To check the remaining time**

Press TIME/MEMO (or TIME on the remote commander) once to see the remaining time of the selection being played; twice to see the total remaining time; once more to return to the initial display. If you have inserted a pause, the displays shows the total remaining time until the pause.

If you have programmed a selection number over 24 "-----" is displayed instead of the actual time.

# Designating the Playing Order of Up To 6 Discs

## —Multi-disc Program

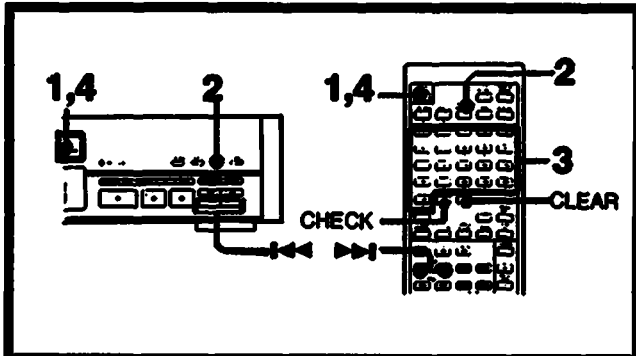

**1**

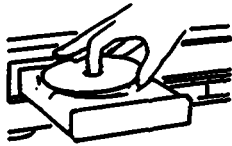

**2**



The indicator above the PROGRAM button on the unit lights up.

**3**

This step can be operated only from the remote commander.

Press selection number in desired order. Selections will be programmed in the selected order.



Current selection    Order    Total time    Chosen selection



**4**

Remove the disc, "MULTI PGM" is displayed and "MULTI" lights up in the window. Insert the second disc, "×DISC-2×" is displayed.

**5**

Repeat steps 3 and 4 to program additional selections. Up to 24 selections from up to 6 discs can be programmed. The total playing time from the first disc will be displayed for the time display.

You can make a program by designation up to 24 selections from up to 6 discs in the order you want them to be played. At the same time, you can adjust the total playing time of the program. This function is convenient for editing tapes.

### To play the program

Insert the first disc and press ►.

When "NEXT DISC" is displayed, replace with the next disc and press ►. Continue replacing until the last disc.

After the last disc have been played, "-END-" will appear in the window and the unit will return to the initial standby condition.

The unit is now ready to repeat the program. You can keep repeating as long as you do not cancel or erase the multi-disc program.

### To stop playing

Press ■.

### To program while checking the total time

Use the ◀◀ and ▶▶ buttons instead of the numeric buttons to choose the desired selections. Choose a selection with the ◀◀ and ▶▶ buttons, check the total time, and then press PROGRAM while the selection number is flashing.

### To program selections for editing a tape

You can insert a pause in your program. Use this function to program selections for both sides of the tape at one time. See page 16 for details.

### To check your program



Press CHECK. Each time you press CHECK, the selection in the program will be displayed along with its selection, order and disc number.

When CHECK is pressed after the last selection "-END-" appears and then the display returns to the initial display.

### To cancel multi-disc program

Press CONTINUE and return to the continuous playing mode. The program will be erased.

### **To change your program**



You can make the following changes before starting play.

#### **To erase the last selection**

Insert the last disc programmed and press CLEAR. Each time you press CLEAR, the last selection in the program will be erased. To continue erasing selections, replace the disc accordingly and repeat the procedure.

If a pause has been programmed, the selections programmed before the pause cannot be cleared.

#### **To add a selection to the end of the program**

Insert a disc and press the numeric button for that selection. You can add a selection during stop.

### **To erase the entire program**

Press  once during stop; twice during play. The program will be erased.

#### **To check the current disc number**

Press TIME/MEMO (or TIME on the remote commander) during stop. The disc number will be displayed.

#### **To check the remaining time**

Press TIME/MEMO (or TIME on the remote commander) once to see the remaining time of the selection being played; twice to see the remaining time of the disc being played. The remaining time of the program cannot be displayed for multi-disc programs.

#### ***If you mistake the disc order***

Even if a disc is inserted in an incorrect order, the selections chosen from that disc will be played. However, when a disc which has already been played is inserted, program play will not proceed. In addition, when a seventh disc is incorrectly inserted, "DISC FULL" will be displayed.

#### ***If you set auto space function***

The auto space cannot be set during multi-disc programming. Be sure to set the auto space before programming.

***The following functions cannot be conducted on Multi-disc programs.***

- Repeat play
- Program bank

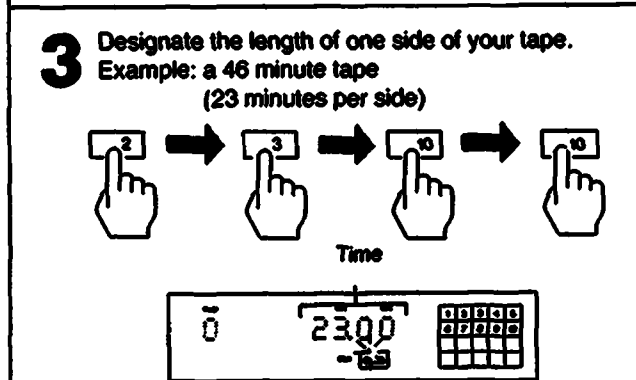
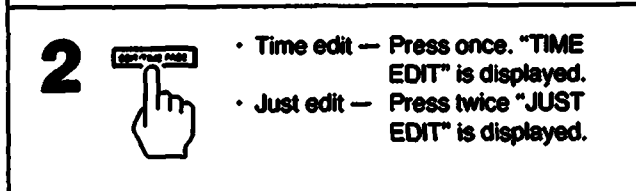
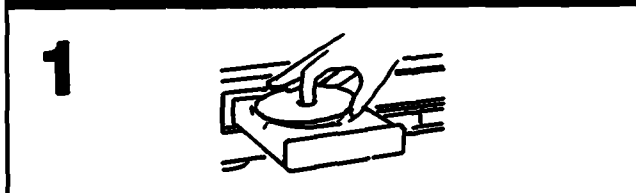
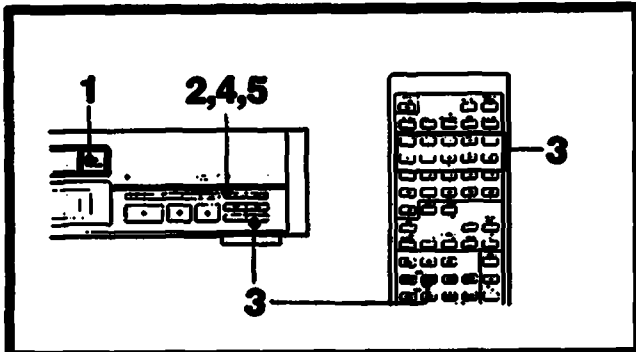

Press **0** for "0".  
You need not press keys for seconds, unless required.

You can designate the tape length easily with **▶▶** button.  
Each time you press **▶▶** button, the display changes to give you the following duration:

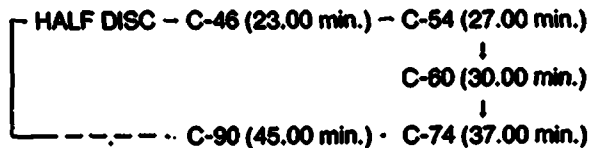

With HALF DISC, the playing time is set to a half of the total playing time.

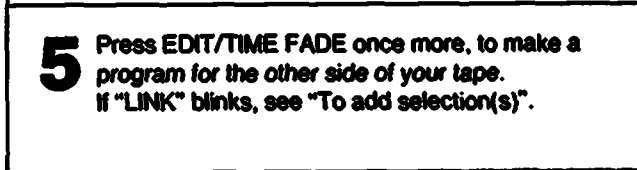
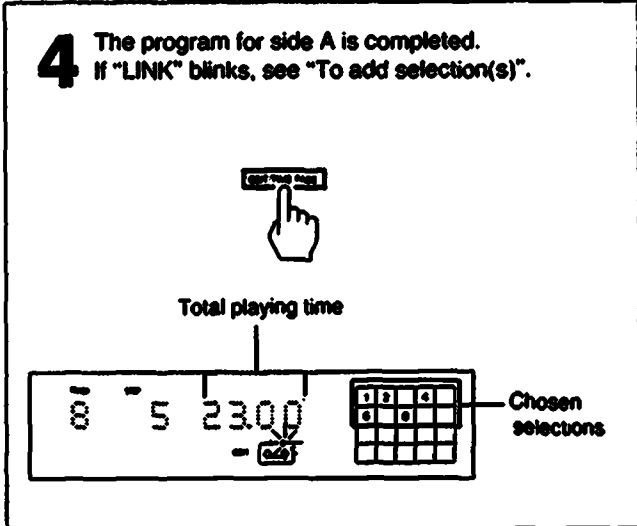

The player can program selections automatically according to your designated total playing time. There are two editing modes you can use. Time Edit programs selections, using each selection once, to fit your designated playing time in the order on the disc. Just Edit re-arranges the selections to fill in your designated playing time as completely as possible. If you have selections you particularly wish to edit, these can be programmed beforehand. In this case, the remaining selections will be programmed to fit the remaining time. Different discs may be used for either program, (sides A and B on your tape), and for any time remaining after executing either editing mode. A program can contain up to 24 steps. These features are useful to edit programs according to the length of a tape on both sides. Also, if the AUTO SPACE function is turned on, the playing time displayed for each selection will include an additional three seconds.

#### About HALF DISC edit

When setting the time at step 3, on the page before if you select the HALF DISC, the programming for Time edit and Just edit are performed in different ways.

- Time edit** — Editing starts at the first selections on the disc. At about half point, selections are distributed to side A and B.
- Just edit** — Changing the order to fit the playing time to a half of playing time as close as possible, selections are distributed to side A and B.

#### Notes

- HALF DISC cannot be set on the disc with selections over 24.
- If selections are programmed beforehand, the HALF DISC mode will not work with Time Edit.

#### To add selection(s) —LINK—

After all selections on the disc have been programmed, if there is a selection(s) within the remaining time, "LINK" and the selection numbers will blink.



To add selection, press the numeric button for the selection number or press the EDIT/TIME FADE again.

When pressing the EDIT/TIME FADE, a program will be made automatically to fit the playing time as close as possible to the remaining time.

If the remaining time can contain other selection(s), "LINK" and the selection number keep blinking. When "LINK" blinks, if the disc is replaced by another disc, the new selection number(s) on the new disc that fit in the remaining time will blink.

"EDIT" disappears when the playing time becomes equal to the designated time. Whether "LINK" is blinking or not, you can replace the disc by another disc and choose selection(s) to fit the remaining time.

To disappear "EDIT" in the window, press ■ button.

#### To play the program

Press ►.

The selections for side A will be played and then the unit will pause. "B" lights up in the tape side indicator. Set the tape to the beginning of side B, then press ► or ■. The selections for side B will be played.

#### Note

Playback can be performed when "EDIT" is displayed.

#### To stop playing

Press ■.

You can play the same program repeatedly as long as you do not cancel time edit/just edit or erase the program.

#### To cancel time edit/just edit

Press CONTINUE and return to the continuous playing mode.

The program will be erased.

#### To erase the entire program

Press ■ once during stop; twice during play.

The program is also erased, when you turn off the unit.

#### To include desired selections in the program

1. Make your own program of the desired selections. See page 16 for instructions.
2. Follow the procedure as shown on the preceding page. Just designate the length of your tape; you need not subtract the length of your program. The unit will place your selections at the beginning of its program and add other selections to fit the remaining time.

#### Note

When you set the playing length to HALF DISC with the Time edit, no priority is designated.

#### To check the program

See page 16.



#### To designate a different time for each side

Execute steps 1 to 4 and press ■. Then repeat steps 2 and 4. Do not execute step 5.

#### If your disc have more than 24 selections

Selections over 24 cannot be programmed with the time edit function; program desired selections before using the time edit function. See page 16 for details.

#### When JUST EDIT programming takes too long

The JUST EDIT programming feature may take a long time if the disc has a lot of selections on it. In this case, you can stop the programming by pressing the ■ button. Selections that best fit the playing time at that point will be programmed.



# On Custom Files

The CD player incorporates a memory in which you can store five types of informations called "custom files".

## Five Custom Files You Can Store in Memory

Program bank	A programmed playing order you store in memory for a disc, so that the disc can be played always in the fixed order. (page 24)
Delete bank	You can store certain selections in memory so that the player will always play only desired selections. (page 25)
Disc memo	You can assign a title within 10 letters to each individual disk. (page 26)
Custom Index	You can assign up to 10 index points on anywhere you want on a disc. (page 28)
Level file	You can assign a playback level to each individual disc, so that the disc can be played automatically on a fixed playback level. (page 29)

### What is this indication?

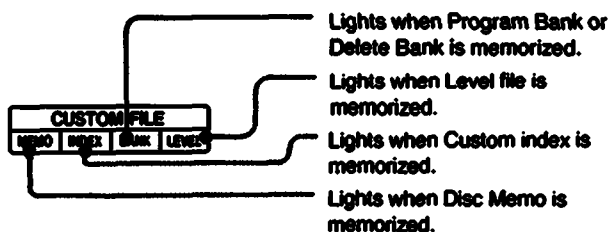

### How many discs can be assigned to custom files?

You can give custom files to up to 185 discs.

But it takes two discs' memory in the following cases:

- When disc memo, custom index and program bank are memorized for one disc at the same time.
- When more than 9 custom indexes and disc memo are memorized for one disc at the same time.
- When custom index and program bank are memorized for one disc at the same time.

### Where are custom files memorized?

Custom files are memorized not in the disc but in the player's memory. So you can't enjoy custom files with the other players without memorizing custom files again.

Custom files are retained for approximately 1 month without AC power supply.

### Custom File Last Mode Memory

The last play mode (current play mode, repeat, auto space and fade time) of a disc containing custom file will be retained in the unit's memory when the disc is removed from the unit. When the disc is inserted again, the last play mode will be recalled. However, if you press the ► button while the disc table is open, the current play mode will take priority over the last play mode memorized.

### What is this indication?

FILE ERASE

This indication appears when FILE is pressed while no custom file can be memorized for the disc currently put in the player. To make a custom file for the disc, clear the custom file of another disc.

### To clear all custom files of a disc at once

You can use this function on a disc you have assigned a disc memo. Press FILE RECALL without the disc in the player and press ERASE. The disc memo and program bank (or the disc memo and custom indexes) are all cleared and "FILE ERASE" appears.

### To clear custom files or to reset memory of all discs at once

When the disc tray is empty, press POWER to turn on the player while keeping ERASE and FILE pressed. "ALL ERASE" is displayed.

### To check the items of the custom files

Press FILE RECALL (while "-NO DISC-" is displayed) without the disc inserted. Each time you press FILE RECALL, the items of the custom files and items of the each column of 

MEMO	INDEX	BANK	LEVEL
------	-------	------	-------

 about the disc are displayed. If you press FILE RECALL when the last disc's information is displayed, "-END-" is displayed and returns to "-NO DISC-" after a few seconds.

### Note on program bank

A single disc cannot be assigned with both a program bank and a delete bank. Multi-disc programs cannot be stored in memory.





# Keeping Your Desired Selections in Memory

## — Delete Bank

### Memorizing Desired Selection

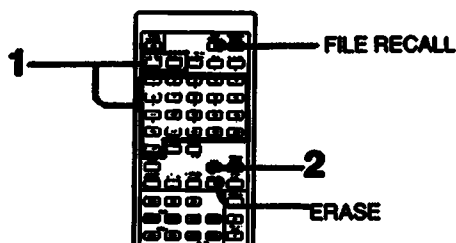

- 1** Select the desired selections. (see page 16)

- 2** Press FILE during stop.



Lights up.

When "BANK" lights, the desired selections are memorized for the delete bank.

After selecting desired selections, you can keep the desired selections memorized. The memorized desired selection are called "Delete Bank".

One delete bank can be made for a disc.

Note, a single disc cannot be assigned with both a program bank and a delete bank.

#### To change the delete bank

Select the desired selections again, and press FILE.

### Playing the Disc Using the Delete Bank

#### Before inserting a disc

- 1 Press CONTINUE or SHUFFLE.
- 2 Press ▲ and put the disc in the disc compartment.
- 3 Press ►.

#### When the disc is in the disc compartment

- 1 Press CONTINUE or SHUFFLE.
- 2 Press FILE RECALL during stop.
- 3 Press ►.

#### To play the selections in another desired selections without clearing the delete bank

Put the disc in the disc compartment, press ■. Select the desired selections again, and press ►. The disc will be played in the newly desired selections. The memorized delete bank won't be cleared. (Press FILE RECALL to check the delete bank.)

#### To play a disc having a delete bank in other modes

To play a disc having a delete bank in other modes. Put the disc in the disc tray, set the player in the desired play mode and press ►.

#### Where is the delete bank memorized?

The delete bank is memorized in the compact disc player's memory. Therefore, if a disc for which you made a delete bank is used with another compact disc player, play using the delete bank is not possible.

#### Note on delete banks

Up to 99 selections can be specified in the delete bank. However, a delete bank will not register if no selections are deleted at all.

### Clearing the Delete Bank

- 1 Put the disc whose delete bank is to be cleared in the player.
- 2 Press FILE RECALL
- 3 Press ERASE.

When "FILE ERASE" is displayed and "BANK" disappears, the delete bank is cleared.

# Assigning Names to a Disc

## —Disc Memo

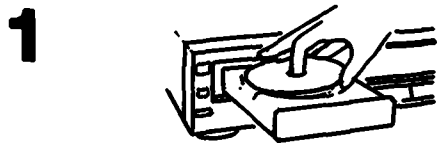
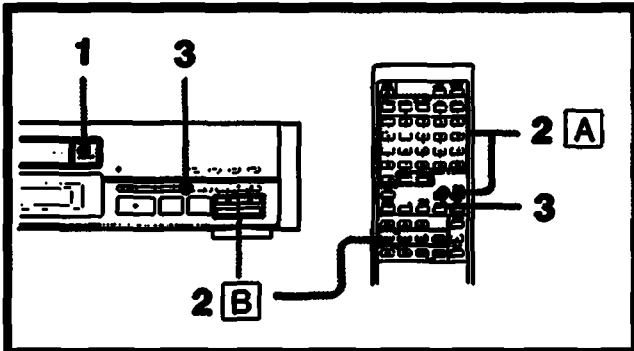

**1** Make sure that the total number of selections and the total playing time are displayed. Then proceed as follows in the stop mode.

### 2 A Using the MEMO INPUT button with the letter buttons on the remote commander

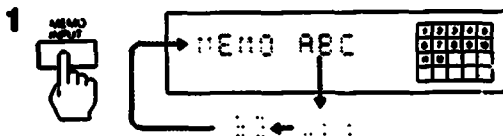

Each time you press MEMO INPUT, the display changes as shown above. Choose the desired capital letters, small letters, or numbers.

### 2 Press the applicable letter button.

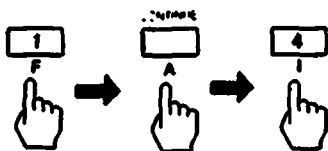

Move the cursor to select the next letter.  
To change to small letters or numbers, return to the step 1.

### B Using the << / >> buttons

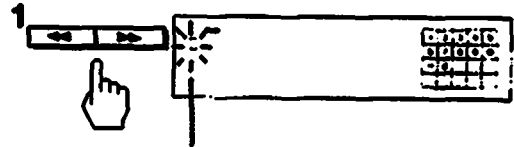

Press << or >> until the desired letter appears  
Example: if >> is pressed 7 times, F appears

### 2 When the desired letter appears, press >>>.

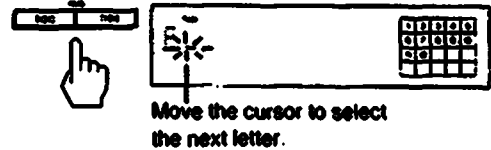

Move the cursor to select the next letter.

### 3

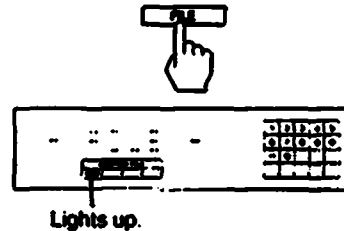

After about 1 second, the memo you have written will be displayed.

Each time the disc is put in the unit, the memo will be displayed.

Using the disc memo function, you can assign a name within 10 letters for each disc. The memo appears in the window every time you put the disc in the player. One name can be assigned for one disc.

"-NO DISC-" can be changed to a desired indication.

#### Usable letters and symbols

For the disc memo, 78 letters and symbols and space can be used. When the ◀▶/▶▶ button is pressed for the first time, the space appears. Each time ▶▶ is pressed, letters and symbols will appear in the following order.

(Space)	A	B	C	D	E	F	G	H	I	J	K	L	M	N	O	P				
Q	R	S	T	U	V	W	X	Y	Z	g	a	b	c	d	e	f	g	h	i	j
k	l	m	n	o	p	q	r	s	t	u	v	w	x	y	z	.	~	=	( )	
( )	!	?	*	/	+	:	.	9	8	7	6	5	4	3	2	1	0	-		

Use ◀▶ to call up a previous character.

#### To rewrite letters or symbols

##### **Before pressing FILE**

Move the cursor under the letter/symbol to be changed, and then select the desired letter/symbol using ◀▶/▶▶. To erase the letter and make space, locate the desired place with ◀▶/▶▶ and press CLEAR.

##### **After pressing FILE**

Repeat from step 2.

##### **Notes**

- Symbols cannot be entered with the letter buttons on the remote commander. To enter symbols, use the ◀▶/▶▶ buttons.
- The only characters that can be entered directly for your disc memo are the yellow letters on the remote commander.

##### **To display the playing time of the disc whose memo has already been memorized**

When the total remaining time of the disc is displayed, if you press TIME/MEMO (or TIME on the remote commander), memo will be displayed.

##### **Where is the disc memo stored?**

The disc memo is stored in the compact disc player's memory. When a disc is put in the player, the player identifies the disc by the total number of selections and the total playing time. If a disc memo has been made for that disc, the player retrieves the memo from its memory and displays it in the window. Therefore, as the disc memo is not located on the disc itself, when the disc is put in another compact disc player, no memo will be displayed.

## Clearing the Disc Memo

- 1 Put the disc whose memo you want to clear in the player.
- 2 Press MEMO INPUT or ◀▶/▶▶.  
The first letter in the memo blinks.
- 3 Press ERASE.  
"FILE ERASE" is displayed in the window.

# Giving a Disc Indexes as You Want

## —Custom Index

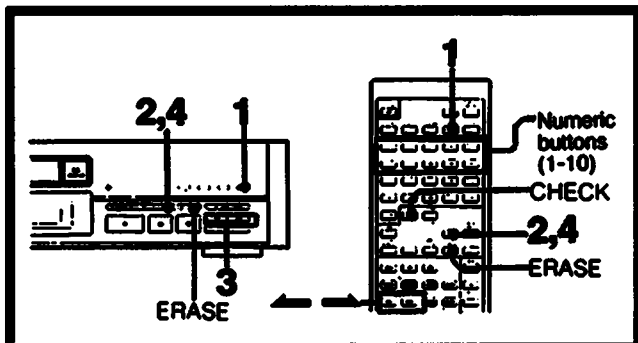

A custom index is a special index that can be assigned to any position you want on the disc. If you assign custom indexes to the positions on a disc, you can easily locate the positions during play, or enjoy repeat play between two adjacent custom indexes.

**If you press FILE in the pause mode**

The rehearsal play is not made and the custom index is assigned immediately at the position where FILE is pressed.

**To release rehearsal play**

Press CLEAR to resume normal play.

**If a new custom index is assigned to a position preceding another index**

Previously existing indexes will be shifted as follows

Example: If you assign a new index between 2 and 3.



## Playing from the Desired Custom Index

**To play from an index to the end of the disc**

1 Press C.INDEX.

2 Select the desired custom index by pressing the corresponding numeric button 1 through 10.

**To play from one index to the next**

1 Press C.INDEX twice so that "C.INDEX 1" and "SINGLE" are displayed.

2 Select the desired custom index by pressing the corresponding numeric button 1 through 10.

**To play repeatedly between adjacent indexes**

Press REPEAT between steps 1 and 2 above. To cancel repeat play, press REPEAT again.

**To access an index during play**

1 Press C.INDEX.

2 Press  $\leftarrow / \rightarrow$  on the remote commander.

$\rightarrow$ : Accesses the next index.

$\leftarrow$ : Returns to the preceding index.

(to go further back, use the numeric button.)

**To change the play mode during play using custom indexes**

During play using custom indexes (in other words, while the music calendar is not displayed), the play mode switches from continuous play to single play and vice versa each time C.INDEX is pressed

**To release play using custom indexes**

Press one of the PLAY MODE buttons (PROGRAM, SHUFFLE or CONTINUE). The music calendar appears.

**During custom index play**

You cannot use the normal index search, however, search of custom index function is possible.

**If you press the M.SCAN in the C.INDEX mode, the beginning of each custom index is played.**

## Clearing Custom Indexes

1 Press C.INDEX.

C.INDEX appears.

2 Press CHECK.

Each time you press CHECK, index number blinks.

Select the index number you want to delete.

3 Press ERASE while index number blinks.

The specified index will be erased and the succeeding index numbers will move up one.

**1** Press C. INDEX during play.



The music calendar will disappear.

**2** Press FILE where you want to assign a custom index. "REHEARSAL" appears in the display window and the portion for 3-second from the point where you pressed FILE is played repeatedly (rehearsal play).

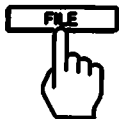

The index number will blink on the music calendar.

**3** Adjust the repeat start point using  $\leftarrow$  or  $\rightarrow$ . Press  $\rightarrow$  to shift the repeat start point forward and  $\leftarrow$  to shift it backward. Pressing  $\leftarrow \rightarrow$  7 times shift the point by approximately 1 second.

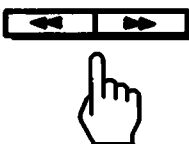

**4** Press FILE to store the custom index. The custom index is assigned to the repeat start point.

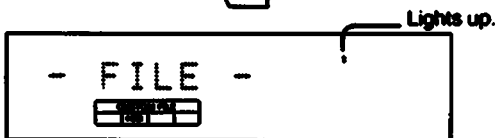
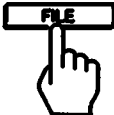

Lights up.

**5** You can assign custom indexes up to 10 positions by repeating steps from 2 to 4.

# Storing an Optimum Playback Level for Each Disc

## —Level File

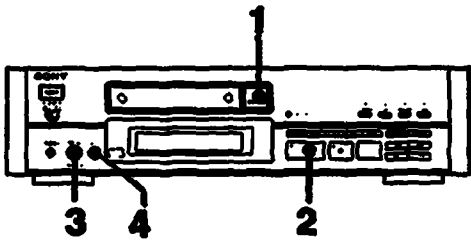

You can have the unit memorize an optimum playback level for each individual disc. Each time you play a disc, the volume will be set to the level memorized for that disc. This function can be used when the amplifier is connected to the VARIABLE LINE OUT terminals or when headphones are used.

### To play the disc using the level file

Each time the disc is inserted into the unit, the LINE OUT/PHONE LEVEL control will automatically turn to the designated playback level.

### When the playback level is changed

Press FILE RECALL during stop.

The LINE OUT/PHONE LEVEL control will automatically be reset to the memorized playback level.

1

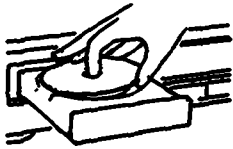

2 Press ► to start play.

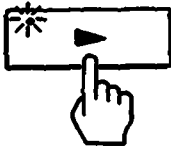

3 Adjust to the desired playback level.



4 Press LEVEL FILE to have the playback level memorized.

LEVEL FILE



Lights up.

## Clearing the Level File

- 1 Put the disc whose level file is to be cleared in the player.
- 2 Press LEVEL FILE.
- 3 Press ERASE.  
"FILE ERASE" is displayed and "LEVEL" disappears in the window.

# Timer Activated Playing

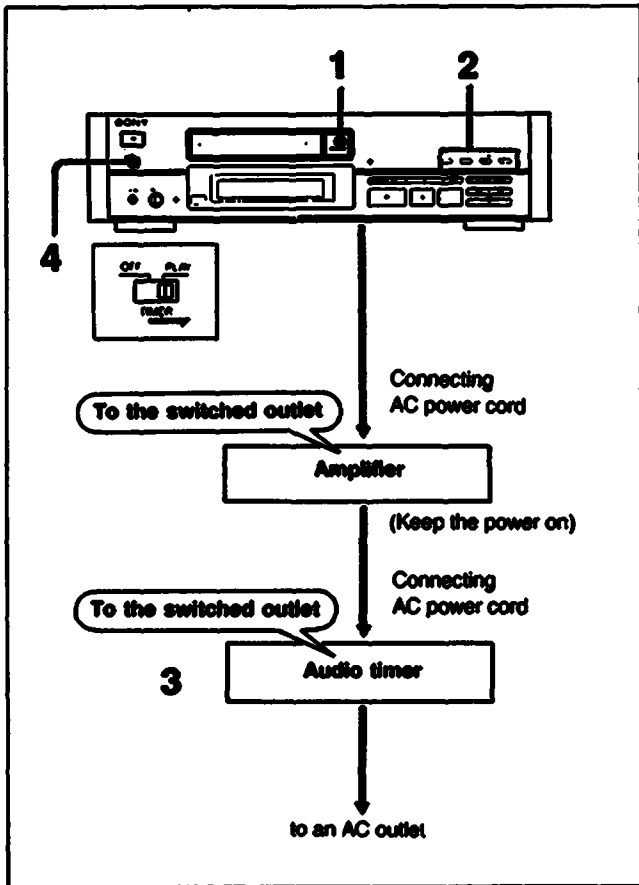

By connecting a commercially available timer, disc play of the desired play mode can be started at any desired time.

1 Insert a disc in the compartment.

2 Select the desired play mode.

3 Set the timer.

4 Set TIMER to PLAY.

**Keep the POWER switch depressed on the player**  
When the timer is set, the power of the player will be cut off. However, be sure to leave the POWER switch on.

**When the timer-activated play ends**  
Be sure to set TIMER to OFF. If the TIMER switch is left at PLAY, the unit will automatically start playing the next time the power is turned on.

**To play in the program play mode**  
Make a program bank (page 24) and then prepare for timer activated playing.

**If you select the custom index play mode**  
Play begins from custom index 1.

# Maintenance

## Cleaning Your Unit

Clean the cabinet, panel and controls with a soft cloth lightly moistened with a mild detergent solution. Do not use any type of abrasive pad, scouring powder or solvent such as alcohol or benzine.

## Cleaning Discs

When a disc becomes dirty, clean it with a cleaning cloth. Wipe the disc from the center out.

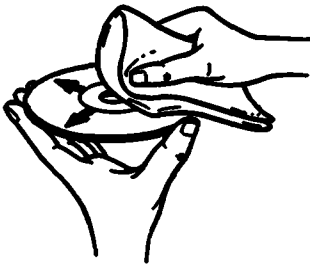

Do not use solvents such as benzine, thinner, commercially available cleaners or anti-static spray intended for analog discs.

# Specifications

## Compact disc player

Frequency response	2 Hz-20 kHz $\pm$ 0.3 dB
Signal to noise ratio	More than 117 dB
Dynamic range	More than 100 dB
Harmonic distortion	Less than 0.0017%
Channel separation	More than 110 dB

## Outputs

LINE OUT (FIXED) (phone jacks)	Output level 2V (at 50 kilo $\Omega$ ) Load impedance over 10 kilo $\Omega$
LINE OUT (VARIABLE) (phone jacks)	Output level max. 2V (at 50 kilo $\Omega$ ) Load impedance over 50 kilo $\Omega$

DIGITAL OUT (OPTICAL) (optical output connector)	Wave length 660nm Output level -18dBm
---	--

HEADPHONES (stereo phone jack)	Output level max. 28 mW Load impedance 32 $\Omega$
-----------------------------------	---

## General

Power requirements	Model for USA 120V AC, 60Hz Model for Australia 240V AC, 50/60Hz
Power consumption	27W
Dimensions	Approx. 470 $\times$ 125 $\times$ 375mm (w/h/d) (18 <sup>5</sup> / <sub>8</sub> $\times$ 5 $\times$ 14 <sup>7</sup> / <sub>8</sub> inches) including projecting parts and controls
Weight	Approx. 12.8 kg. (27 lbs 74 oz), net

## Remote commander RM-D991 (supplied)

Remote control system	Infrared control
Power Requirements	3 V DC with two batteries size AA (IEC designation R6)
Dimensions	62 $\times$ 18 $\times$ 175 mm (w/h/d) (2 <sup>1</sup> / <sub>2</sub> $\times$ 2 <sup>2</sup> / <sub>32</sub> $\times$ 7 inches)
Weight	130g (4.6 oz) including batteries

## Supplied accessories

Connecting cord (1) (2 phono plugs $\leftrightarrow$ 2 phono plugs)
Remote commander (1)
Size AA batteries (2)
Screws (8)

## Optional accessory

Audio Optical connecting cord POC-15
--------------------------------------

Design and specifications subject to change without notice.

# Troubleshooting Guide

Before going through the check list below, first refer back to the connections and operating procedures. Should any problem persist after you have made these checks, consult your nearest Sony service facility.

Symptom	Cause	Remedy
The disc tray does not close.	The disc is not placed correctly.	Place the disc correctly on the disc tray
Play does not start.	Dirty disc	Clean the disc.
	The disc is inserted upside down.	Insert the disc with the printed side up
	The player is in the pause mode.	Press II or ► to release pause.
	Moisture condensation	Leave the player turned on for approximately one hour.
"—NO DISC—" is displayed	There is no disc in the unit.	Insert a disc.
Play begins only by turning on the power.	The TIMER switch is set to PLAY.	Set the TIMER switch to OFF.
Display window does not illuminate even when the power is turned on.	The DISPLAY MODE button was pressed.	Press the button again.
Sound is not heard.	Loose connection	Insert the plug firmly.
	Connection is incorrect.	Check the connection referring to "To connect to an Amplifier".
	The LINE OUT/PHONE LEVEL control is set to the minimum.	Turn the control clockwise.
Play does not begin from the first selection.	The player is in the PROGRAM, or SHUFFLE or C.INDEX mode.	Press CONTINUE.
"—OVER—" is displayed.	►► was continuously pressed at the end of the disc.	Press ◀◀ or ◀◀ to return to normal indication.
The remote commander does not operate the unit.	The batteries are run down.	Replace both batteries.
	The remote commander is not pointed at the remote sensor.	Point the remote commander at the sensor.
	There is an obstacle between the remote commander and the unit.	Remove the obstacle.
	The remote commander is too far from the unit.	Move closer.
Any operation is not possible.	The internal control program may not run.	Turn off the power and turn it on again.